

CANDIDATE  
NAME

CENTER  
NUMBER

--	--	--	--	--

CANDIDATE  
NUMBER

--	--	--	--

\* 5 1 4 3 3 7 4 8 8 5 \*

**MATHEMATICS (US)**

**0444/33**

Paper 3 (Core)

**October/November 2014**

**2 hours**

Candidates answer on the Question Paper.

Additional Materials: Geometrical instruments  
Electronic calculator

**READ THESE INSTRUCTIONS FIRST**

Write your Center number, candidate number and name on all the work you hand in.

Write in dark blue or black pen.

You may use an HB pencil for any diagrams or graphs.

Do not use staples, paper clips, glue or correction fluid.

**DO NOT WRITE IN ANY BARCODES.**

Answer **all** questions.

If work is needed for any question it must be shown in the space provided.

Electronic calculators should be used.

If the degree of accuracy is not specified in the question, and if the answer is not exact, give the answer to three significant digits.

Give answers in degrees to one decimal place.

For  $\pi$ , use either your calculator value or 3.142.

The number of points is given in parentheses [ ] at the end of each question or part question.

The total of the points for this paper is 104.

**Write your calculator model in the box below.**

This document consists of **16** printed pages.

**Formula List**

Area,  $A$ , of triangle, base  $b$ , height  $h$ .

$$A = \frac{1}{2}bh$$

Area,  $A$ , of circle, radius  $r$ .

$$A = \pi r^2$$

Circumference,  $C$ , of circle, radius  $r$ .

$$C = 2\pi r$$

Lateral surface area,  $A$ , of cylinder of radius  $r$ , height  $h$ .

$$A = 2\pi rh$$

Surface area,  $A$ , of sphere of radius  $r$ .

$$A = 4\pi r^2$$

Volume,  $V$ , of prism, cross-sectional area  $A$ , length  $l$ .

$$V = Al$$

Volume,  $V$ , of cylinder of radius  $r$ , height  $h$ .

$$V = \pi r^2 h$$

Volume,  $V$ , of sphere of radius  $r$ .

$$V = \frac{4}{3}\pi r^3$$

1

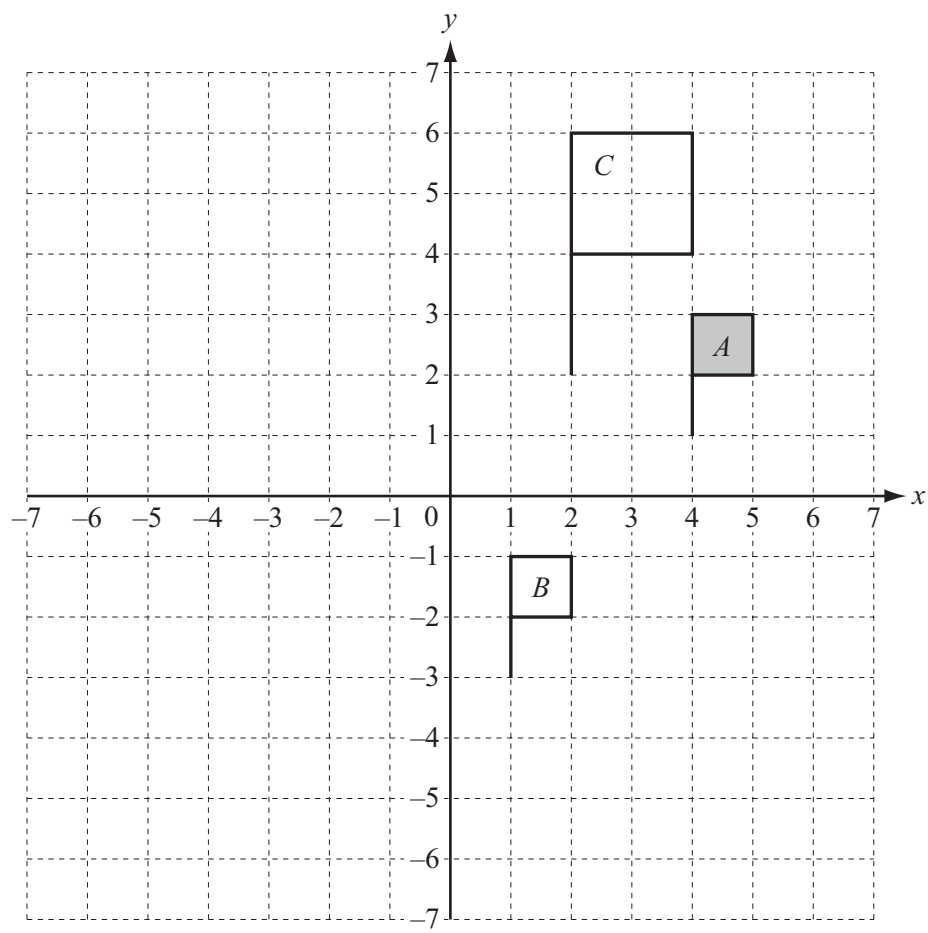

- (a) On the grid,
- (i) draw the line  $x = 1$ , [1]
  - (ii) reflect flag  $A$  in the line  $x = 1$ , [1]
  - (iii) rotate flag  $A$  through  $90^\circ$  counterclockwise about the origin. [2]

(b) Describe fully the **single** transformation that maps

- (i) flag  $A$  onto flag  $B$ ,  
*Answer(b)(i)* ..... [2]

- (ii) flag  $A$  onto flag  $C$ .  
*Answer(b)(ii)* ..... [3]

- 2 (a) A group of 20 boys were asked which type of movie they liked best. Each boy's choice is shown below.

Action	Science Fiction	Comedy	Drama	Comedy
Horror	Action	Science Fiction	Science Fiction	Comedy
Comedy	Horror	Comedy	Horror	Comedy
Horror	Action	Action	Horror	Drama

- (i) Complete the frequency table for the results. You may use the tally column to help you.

Type of movie	Tally	Frequency
Action		
Horror		
Science Fiction		
Comedy		
Drama		
Total		20

[2]

- (ii) Draw a bar chart to show this information. Complete the scale on the frequency axis.

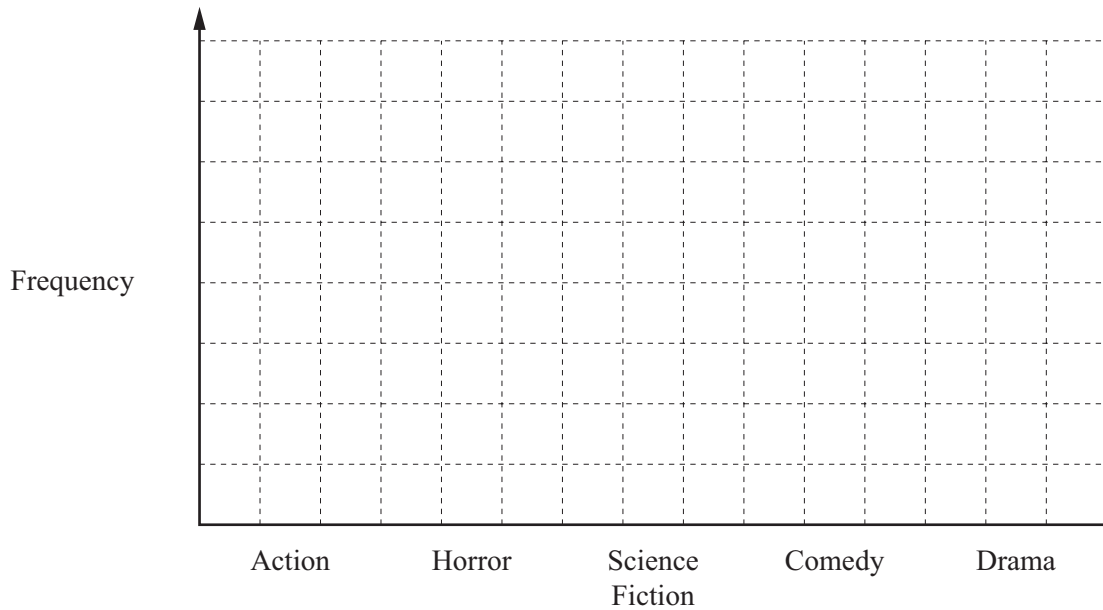

[3]



- (b) A group of 24 girls were also asked which type of movie they liked best. The results are shown in the table below.

Type of movie	Frequency
Action	5
Horror	3
Science Fiction	2
Comedy	6
Drama	8

One of these girls is picked at random.

Find the probability that she liked comedy or drama best.

*Answer(b)* ..... [1]

- (c) Khalid says:

Comedy movies are equally popular with boys and girls.

Is he correct?

Give a reason for your answer.

*Answer(c)* ..... because .....

..... [1]

- (d) When Khalid watches a movie, the probability it is a horror movie is 0.35 .  
Khalid plans to watch 20 movies in December.

Calculate the expected number of movies Khalid watches in December that are **not** horror movies.

*Answer(d)* ..... [2]

- 3 (a) Lei earns \$6.75 per hour.  
One week she works for 37 hours.
- How much does she earn this week?

Answer(a) \$..... [1]

- (b) One month Lei earns \$1080.  
20% of her earnings are taken off for tax.
- Show that the amount of money she has left is \$864.

Answer(b)

[1]

- (c) Lei divides \$864 in the ratio bills : spending money : savings = 9 : 4 : 2.
- (i) Work out how much spending money she has.

Answer(c)(i) \$..... [2]

- (ii) What fraction of the \$864 does she use for bills?  
Give your answer in its simplest form.

Answer(c)(ii) ..... [2]

(d) Lei wants to buy a computer.

(i)

Computer  
\$425 + sales tax

The sales tax is 15%.

Work out the total cost of this computer.

*Answer(d)(i)* \$ ..... [2]

(ii) Lei goes on holiday to London.

The exchange rate between dollars and pounds (£) is \$1 = £0.52 .

The total cost of the same computer in London is £235.

Work out how much less, in pounds, the computer costs in London.

*Answer(d)(ii)* £ ..... [2]

(e) Lei inherits \$1400.

She spends \$175 on a camera.

(i) Work out \$175 as a percentage of \$1400.

*Answer(e)(i)* ..... % [1]

(ii) Lei invests the remaining \$1225 for 3 years at a rate of 4.5% per year compound interest.

How much interest does she receive after 3 years?

*Answer(e)(ii)* \$ ..... [3]

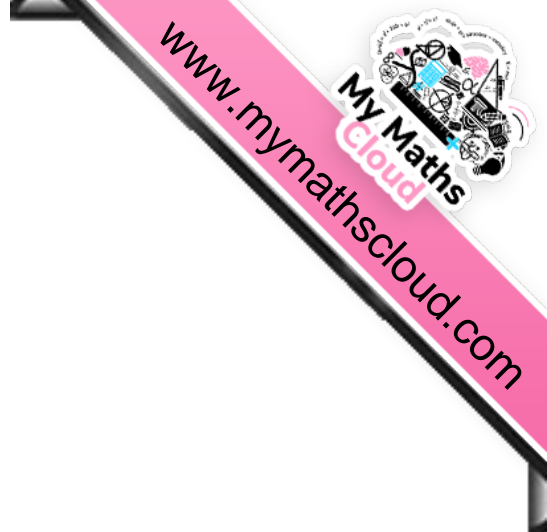

- 4 Sylvain leaves his house at 09 30 to cycle to Southfield Lake. He cycles for 4 km then waits for his friend Michel. Both boys then cycle to the lake together. The travel graph shows Sylvain's journey and the time they spent at the lake.

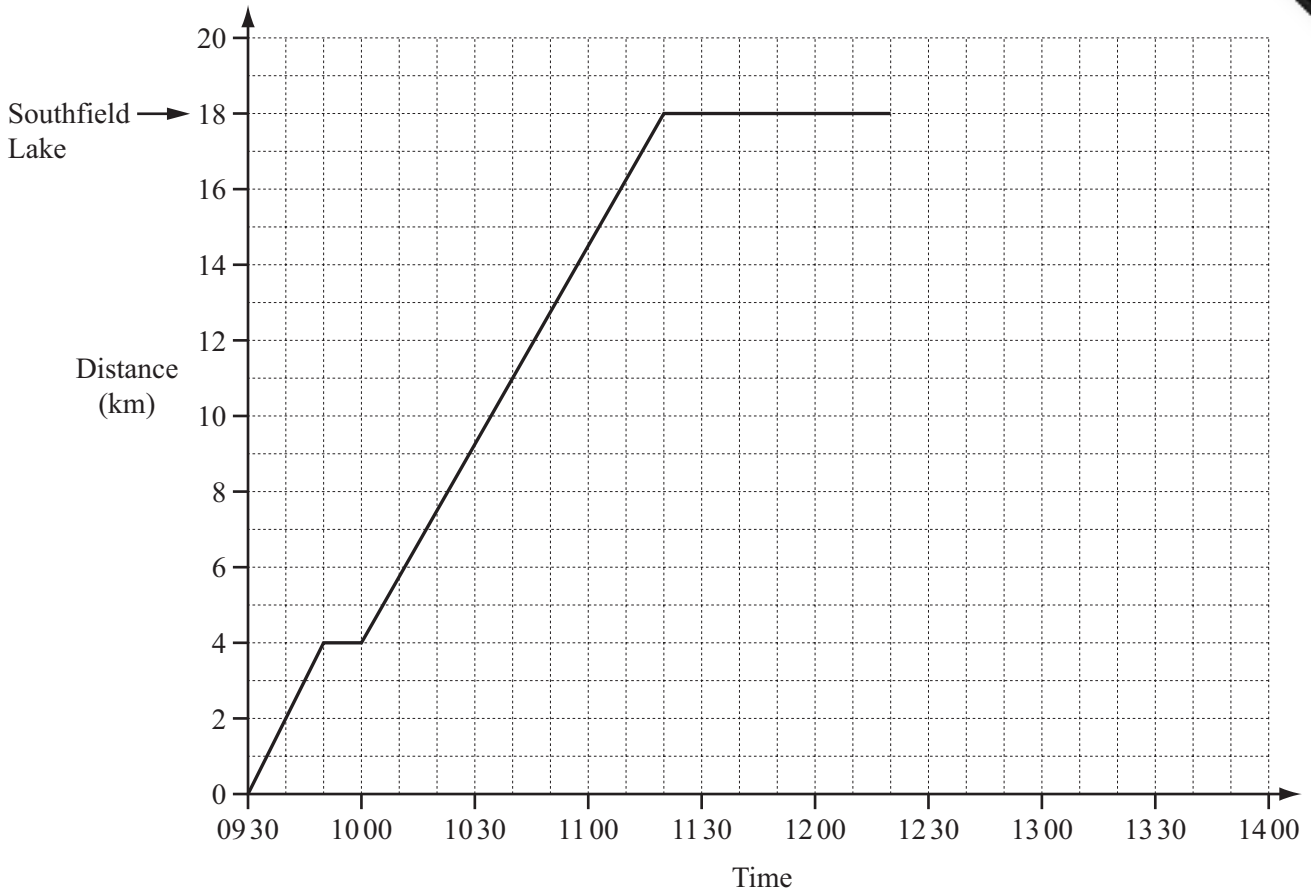

- (a) Write down how long Sylvain waits for Michel.

Answer(a) ..... min [1]

- (b) Is Sylvain's speed faster before or after he meets Michel?  
Explain how you know.

Answer(b) ..... because ..... [1]

- (c) Write down the time Sylvain and Michel arrive at the lake.

Answer(c) ..... [1]



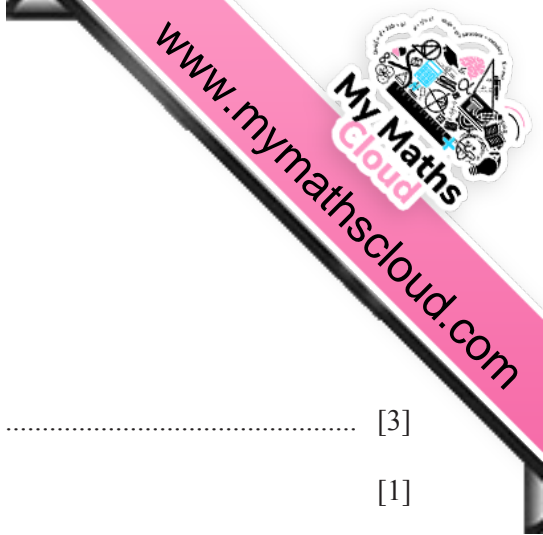

- (d) Sylvain and Michel stay at the lake until 12 20.  
They then cycle back to Sylvain’s house at a speed of 12 km/h.
- (i) Find the time at which they arrive.

Answer(d)(i) ..... [3]

- (ii) Complete the travel graph. [1]

- (e) Manon plans to go to Southfield Lake by bus from High Street.  
Here is the bus timetable.

Railway Station	08 45	09 15	09 45	10 15	10 45	11 15
High Street	08 57	09 27	09 57	10 27	10 57	11 27
Hospital	09 12	09 42	10 12	10 42	11 12	11 42
Southfield Lake	09 21	09 51	10 21	10 51	11 21	11 51
Country Park	09 50	10 20	10 50	11 20	11 50	12 20

- (i) Manon arrives at Southfield Lake just before 11 30.

Write down the time of the bus she caught from High Street.

Answer(e)(i) ..... [1]

- (ii) How long does the journey from High Street to Southfield Lake take?

Answer(e)(ii) ..... min [1]

- (f) Southfield Lake is 13 km from Manon’s house on a bearing of 110°. Mark the position of the lake on the scale drawing below.  
Use a scale of 1 centimeter represents 4 kilometers.

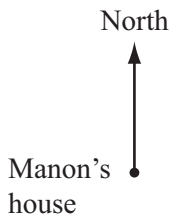

[2]

5 (a)

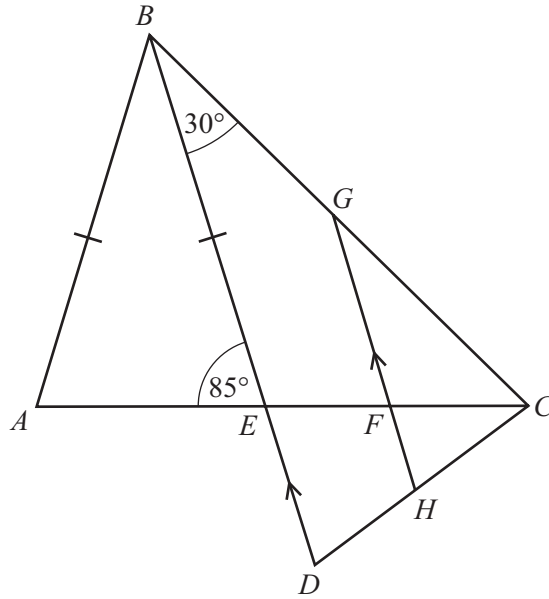

NOT TO SCALE

In the diagram,  $ABC$  and  $DEC$  are triangles.  
 $AB = BE$  and  $BE \parallel ED$ .  
 Angle  $AEB = 85^\circ$  and angle  $CBE = 30^\circ$ .

(i) Find angle  $EAB$ .

Answer(a)(i) Angle  $EAB = \dots\dots\dots$  [1]

(ii) Find angle  $ABE$ .

Answer(a)(ii) Angle  $ABE = \dots\dots\dots$  [1]

(iii) Find reflex angle  $ABC$ .

Answer(a)(iii) Angle  $ABC = \dots\dots\dots$  [1]

(iv) Find angle  $BEC$ .

Answer(a)(iv) Angle  $BEC = \dots\dots\dots$  [1]

(v) Find angle  $EFH$ .

Answer(a)(v) Angle  $EFH = \dots\dots\dots$  [1]

(vi) Find angle  $BCE$ .

Answer(a)(vi) Angle  $BCE = \dots\dots\dots$  [1]

(vii) Complete the following statement.

Triangle ..... is similar to triangle .....

(b) For a regular 12-sided polygon, find the size of

(i) an exterior angle,

*Answer(b)(i)* ..... [2]

(ii) an interior angle.

*Answer(b)(ii)* ..... [1]

(c)

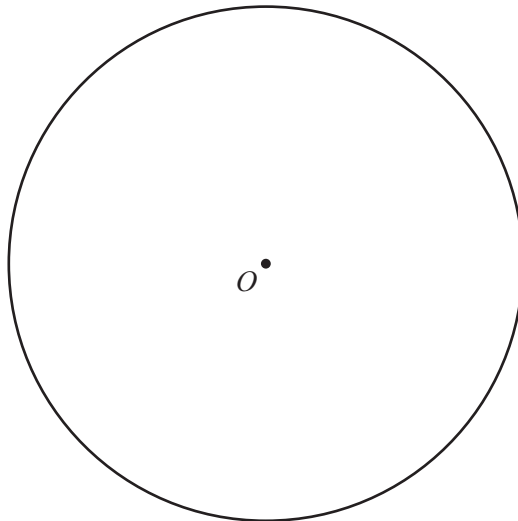

The diagram shows a circle, center  $O$ .

On the diagram, draw

(i) a radius,

[1]

(ii) a chord.

[1]

(d) Complete the statements.

(i) The order of rotational symmetry of a rectangle is .....

[1]

(ii) A parallelogram has ..... line(s) of symmetry.

[1]

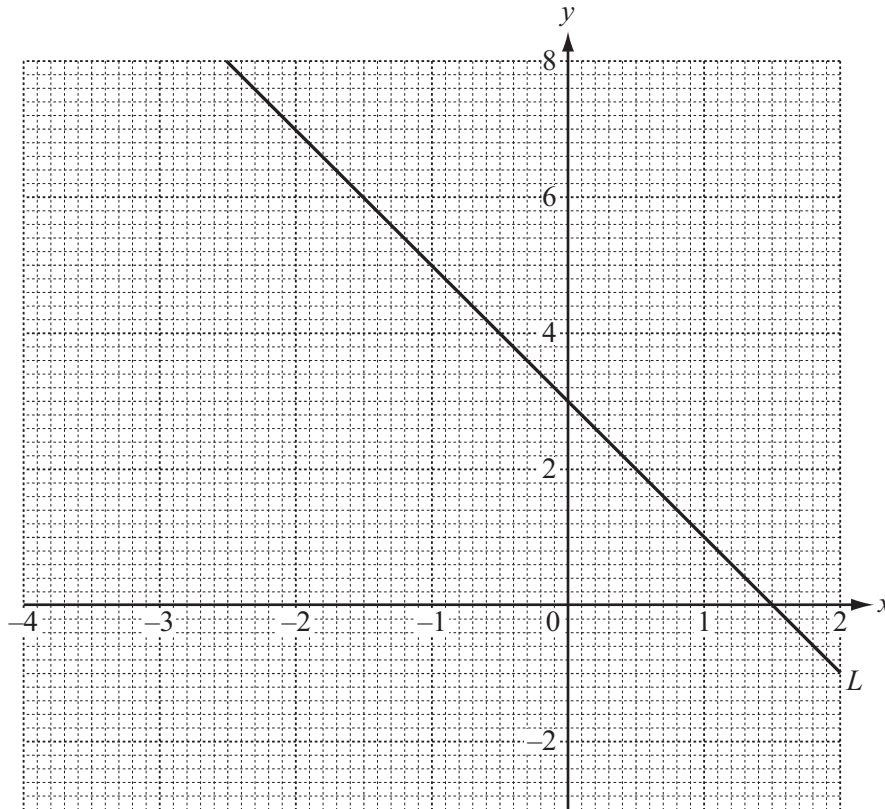

(a) The line  $L$  is drawn on the grid.

(i) Work out the slope of  $L$ .

Answer(a)(i) ..... [2]

(ii) Write down the equation of  $L$  in the form  $y = mx + b$ .

Answer(a)(ii)  $y =$  ..... [1]

(b) (i) Complete the table of values for  $y = 6 - 2x - x^2$ .

$x$	-4	-3	-2	-1	0	1	2
$y$	-2	3				3	-2

[3]

(ii) On the grid, draw the graph of  $y = 6 - 2x - x^2$  for  $-4 \leq x \leq 2$ .

[4]

(iii) Use your graph to solve the equation  $6 - 2x - x^2 = 0$ .

Answer(b)(iii)  $x =$  ..... or  $x =$  ..... [2]

(c) Write down the co-ordinates of the points of intersection of  $L$  with your graph.

Answer(c) (..... , ..... ) and (..... , ..... ) [2]

- 7 In this question all lengths are in centimeters.

$ABC$  is an isosceles triangle.  
 $AC = 2x - 3$  and  $BC = x + 2$ .

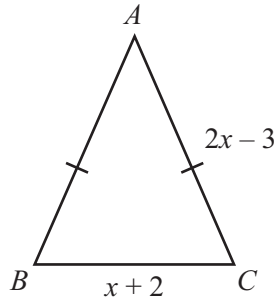

NOT TO  
SCALE

- (a) Write down an expression for  $AB$ .

Answer(a)  $AB = \dots\dots\dots$  [1]

- (b) Write down and simplify an expression for the perimeter of the triangle.

Answer(b)  $\dots\dots\dots$  cm [2]

- (c) A rectangle has length  $3(x - 4)$  and width  $(14 - x)$ .

- (i) Write down and simplify an expression for the perimeter of this rectangle.

Answer(c)(i)  $\dots\dots\dots$  cm [2]

- (ii) The triangle and the rectangle have the same perimeter.

Write down an equation and use it to find  $x$ .

Answer(c)(ii)  $x = \dots\dots\dots$  [2]

- (d) Find the length and width of the rectangle.

Answer(d) Length =  $\dots\dots\dots$  cm

Width =  $\dots\dots\dots$  cm [2]

- (e) Work out the area of the rectangle.

Answer(e)  $\dots\dots\dots$   $\text{cm}^2$  [1]

8 (a)

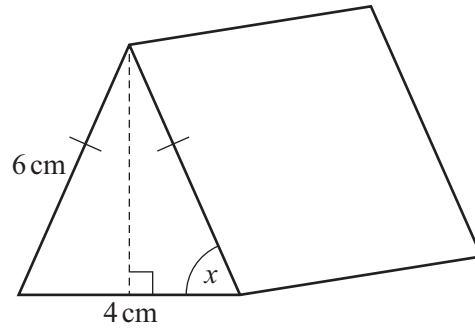
NOT TO  
SCALE

Candies are packed in a box.

The cross section of the box is an isosceles triangle with sides 6 cm and base 4 cm.

(i) Write down the mathematical name for the box.

*Answer(a)(i)* ..... [1](ii) Calculate the size of angle  $x$ .*Answer(a)(ii)* ..... [2](iii) The surface area of the box is  $15\,063\text{ mm}^2$ .

Change this surface area to square centimeters.

*Answer(a)(iii)* .....  $\text{cm}^2$  [1]

(iv) The box contains 118.09 g of candies.

Write this mass correct to the nearest 10 g.

*Answer(a)(iv)* ..... g [1]

(b)

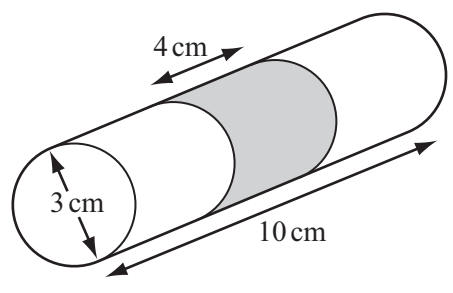

NOT TO SCALE

Another box of candies is in the shape of a cylinder. The cylinder has diameter 3 cm and length 10 cm.

(i) Calculate the volume of the cylinder.

Answer(b)(i) ..... cm<sup>3</sup> [3]

(ii) A label of width 4 cm fits around the cylinder with no overlap.

Calculate the area of the label.

Answer(b)(ii) ..... cm<sup>2</sup> [3]

Question 9 is printed on the next page.

9 Tables and chairs can be arranged in two different patterns.

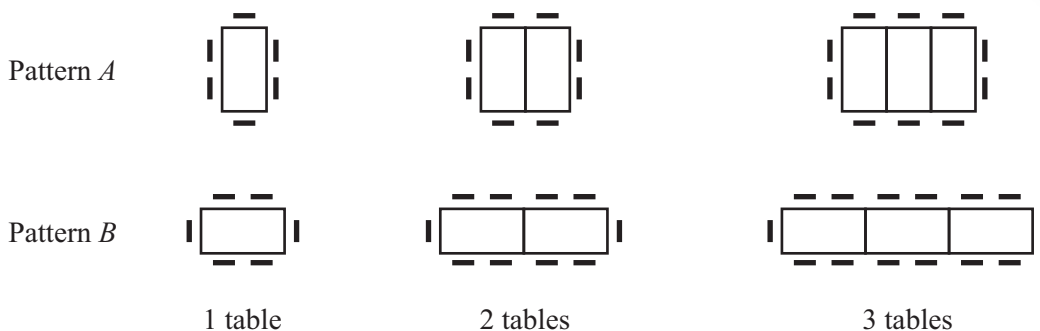

(a) Complete the following table.

Number of tables	1	2	3	4		8
Number of chairs in Pattern A	6	8				
Number of chairs in Pattern B	6	10				

[5]

(b) How many chairs are needed with  $n$  tables

(i) in Pattern A,

Answer(b)(i) ..... [2]

(ii) in Pattern B?

Answer(b)(ii) ..... [2]

(c) Sofia needs to arrange tables to seat 66 people.

Which pattern uses the least number of tables and by how many?

Answer(c) Pattern ..... by ..... tables [3]

Permission to reproduce items where third-party owned material protected by copyright is included has been sought and cleared where possible. Every reasonable effort has been made by the publisher (UCLES) to trace copyright holders, but if any items requiring clearance have unwittingly been included the publisher will be pleased to make amends at the earliest possible opportunity.

Cambridge International Examinations is part of the Cambridge Assessment Group. Cambridge Assessment is the brand name of University of Cambridge Local Examinations Syndicate (UCLES), which is itself a department of the University of Cambridge.